

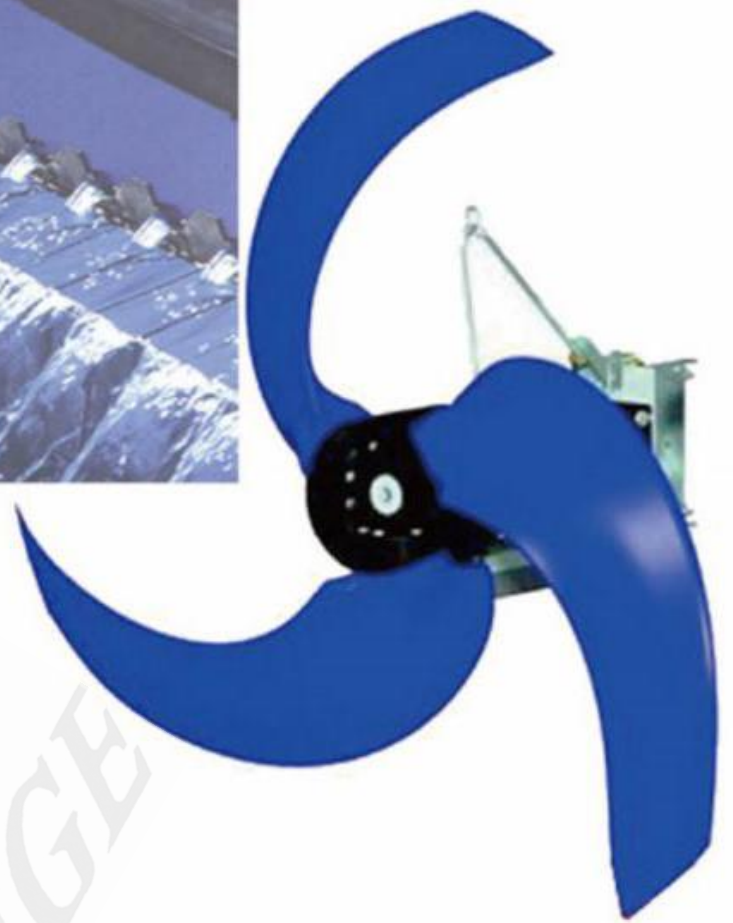

# 潜水推流器 Submersible Flow Propeller



2017

南京贝特环保通用设备制造有限公司  
Nanjing Beite Environmental Protection GE Manufacture Co., Ltd.

## QDT型潜水推流器

### QDT Type Submersible flow propeller

QDT型潜水推流器，在水处理工艺流程中，广泛应用于氧化沟推流，各类生化池的搅拌，同时也可用于河流防冻，景观水循环等。低速推进器由潜水电机、减速装置、叶桨和安装系统等组成。其特点是配套功率小（1.5-9KW），转速低（34-85r/min），叶桨直径大（1100-3000mm），产生大体积流场，服务范围广。后掠式香蕉型叶桨设计，具有自洁功能，采用聚氨脂或增强玻璃钢成型，具有重量轻、强度高、耐腐蚀等优点，其优异的水力性能，可保证在低速的运动状态下与液体产生良好的阻尼效果，从而创建出柔和的水流。该系列产品除了具有推流和创建水流的作用外还具有搅拌功能。如图。



QDT type Submersible flow propeller is extensively used for the oxidizing flow propelling and agitation in various types of biochemical tanks during the water treatment process, also can be used for river frost protection and, landscape water circulation etc.. The low-speed flow propeller consists of submersible motor, speed-reducing device, blades, and installation system etc. The product is characterized by low power (1.5-9KW), low rotate speed (34-85rpm), large diameter of the blades (1100-3000mm), low-speed rotation, production of large-volume flow field and wide scope of service. The sweptback, banana-shaped blades have self-cleaning function, which is finishing cast with PU or glass fibre reinforced plastics and highlighted by light weight, high strength, and good anticorrosion etc. The excellent frictional property can ensure the a good damping effectiveness with the fluid in low speed movement status to produce gradual water flow. Besides the flow propelling and producing water flow, this series of products also have mixing function as shown in the drawing.

QDTA型潜水推流器是我公司自主研发替代QDT型的改进型产品，其特点是低能耗、大推力。在保障主机可靠性的前提下，选配高效率的减速装置，丰富机型配置，提高输出功率，并使运行更加平稳；在叶桨的设计上由原来的“香蕉型”叶桨改为“阔叶型”叶桨。改进后的QDTA型叶桨比传统QDT型叶桨的比表面积提高1/3，同时采用法兰式叶桨定位，比原有柱销式要更加精确可靠，在同等推流能力下，实现节能30%以上。其中改进后的三叶型推流器，在同等转速及叶桨直径条件下，推流能力提高20%以上，同时具备可靠性高、稳定性强的特点，为工程应用提供了更加丰富的选择。



QDTA type low speed flow propeller is developed and improved by ourselves to replace QDT type products, it is characterized by low energy consumption and large thrust. On the premise of ensuring the mainframe reliable, firstly the speed reducer selects a high efficiency one, the output power is improved, and running is more smoothly; secondly the blade design has been changed from broad leaf type to banana type, the specific surface area of QDTA blade enlarged 1/3 comparing with QDT blade after improvement, furthermore, the flange blade positioning is more precise and reliable than the old pin type, the thrust increased 30% Which improved QDTA type using three vanes, in the same conditions of speed and blade turbine diameter, the plug-flow capacity increased by 20% or more, along with high reliability, stability and strong features for engineering applications to provide a more extensive selection than the original type without increasing the matching power. This shows that the effectiveness of QDTA propeller is obviously improved after improvement, which has been a proffered product among the congener equipments.



QDTM型填料流化推流器是我公司自主研发生产的一种适用于水处理流化床生物膜反应工艺（简称MBBR工艺），完成含悬浮填料生化反应池内对水体推流、并使生物膜填料流化悬浮的新型推流器。

该型推流器的特点在于，特殊设计的三叶不锈钢叶轮与优化的转速和功率配置，能满足表面附着生物膜的填料在水中保持良好的流化悬浮状态，并防止填料受叶片的刚性撞击而造成的破损。流线型的筒形整体式不锈钢外壳，可使填料对机壳的磨损最小，水力效率达到最优化。在流线型机体内整合了新一代节能电机以及整装式高扭矩的高效齿轮减速机，整体动力方案节能、高效、长寿命。针对生物膜反应工艺专门设计的倾角（15°、22°、30°）可调式的安装动作机构，可满足现场推流器对生物反应池整体优良的流化运动效果，有效提高反应效率。



The QDTM type submersible impeller is developed by our company, suitable for process of water treatment fluidized bed biofilm reactor (referred to as the MBBR process). The new impeller can promote the flow of water containing suspended filler biochemical reaction tank, and make Biofilm fluidized suspension

The impeller is characterized by: the special design of clover stainless steel impeller with optimized speed and power configuration, to meet the filler adhered to the surface biofilm maintain good fluidization state of suspension in the water, And prevent the damage of filler leaves caused in the impeller impact. The streamlined overall cylindrical stainless steel housing can make the attrition on the chassis minimum, and the hydraulic efficiency is optimized.

The streamlined machine body integration of a new generation of energy-saving motors as well as self-contained high-torque, high efficiency planetary gear reducer, the overall power solutions is energy-saving and efficient, long-life. The adjustable mounting angle (15 ° , 22 ° , 30 ° ) action machine is specially designed for biofilm reactor technology, to meet the bioreactor excellent overall flow state and effectively improve the efficiency of the reaction.

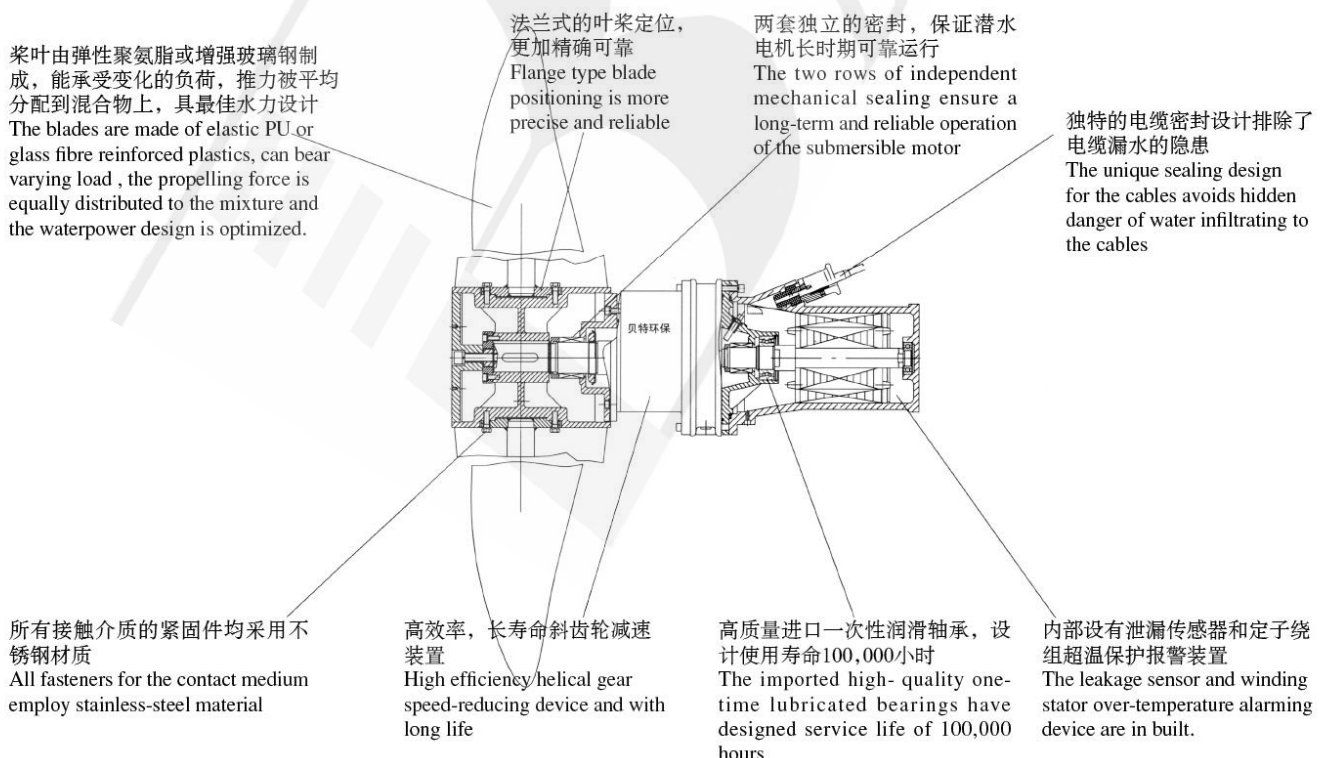

## 应用范围 Scope of Application

潜水推流器主要运用在市政和工业污水处理过程中的混合、搅拌和环流，也可用作景观水循环的推流设备，通过搅拌达到创建水流作用，有效阻止悬浮物沉降。

The submersible mixers are mainly used for mixing, agitating and making ring flows in the process of municipal and industrial sewage treatment and can also be used for equipment maintenance of the landscape water circulation; through agitation, they can achieve the function of creating water flow, improving water quality, increasing oxygen content in the water and effectively preventing the sedimentation of the suspended substances.



## 使用条件 Conditions of Application

为了保证潜水推流器的正常工作，请正确选择工作环境和运行模式。

In order to ensure the normal operation of the submersible mixer, please make correct selection of the operating environment and the operating modes.



最高介质温度不超过40℃；

The highest temperature of the medium shall not exceed 40℃；

介质的pH值范围：5~9；

The scope of pH value of the medium:5~9；

介质密度不超过1150Kg/m<sup>3</sup>；

The density of the medium shall not exceed 1150Kg/m<sup>3</sup>；

潜水深度不超过20m。

The depth of submersion shall not exceed 20m.

▲特别提示：潜水推流器必须完全潜入水中工作，不能在易燃易爆和强腐蚀性  
及高温的环境中工作。针对特殊环境下的要求，我公司可为用户提供特殊设计。

▲Special Warning: The submersible mixer must completely submerge in the

water and cannot operate in the inflammable, explosive, highly corrosive and high-temperature environment. In line with the requirement of the special environment, our company can provide special design for the users.

## 型号表示方式 Model of Model Denotation

QDT□ □/□/□-□/□

材质（P-叶桨为聚氨脂；G-叶桨为玻璃钢）

Material (blades are made of PU; G- glasfiber reinforced polyester)

电机额定功率(kW) Rated power of the motor(kW)

叶片数量 Number of vane

额定转速(r/min) Rated rotate speed (rpm)

叶轮（桨）直径Diameter of the blade

潜水推流器英文代号，A为改进型，M为填料流化型

Letter code of the submersible flow propeller, A is the imoroved type



性能参数 Performance Parameters

型号Model		电机功率 (kW) Motor power	额定电流 (A) Rated current	叶轮转速 (r/min) rpm of impeller	叶片数量 (set) Num. of vane	叶轮直径 (mm) Diameter	推力 (N) Thrust	重量 (Kg) Weight
低速推流 LowSpeed Flow Propeller	QDTA1100/43/2-1.5/G/P	1.5/4	3.7	43	2	1100	860	170
	QDTA1100/52/2-2.2/G/P	2.2/4	4.9	52	2	1100	1100	172
	QDTA1100/63/2-3/G/P	3/4	6.6	63	2	1100	1500	175
	QDTA1100/85/2-4/G/P	4/4	8.6	85	2	1100	1840	177
	QDTA1400/34/2-2.2/G/P	2.2/4	4.9	34	2	1400	1430	180
	QDTA1400/43/2-3/G/P	3/4	6.6	43	2	1400	1870	183
	QDTA1400/52/2-4/G/P	4/4	8.6	52	2	1400	2150	186
	QDTA1400/63/2-5.5/G/P	5.5/4	11.3	63	2	1400	2740	189
	QDTA1800/34/2-3/G	3/4	6.6	34	2	1800	2040	210
	QDTA1800/43/2-4/G	4/4	8.6	43	2	1800	2710	212
	QDTA1800/47/2-5.5/G	5.5/4	11.3	47	2	1800	3320	291
	QDTA1800/63/2-7.5/G/P	7.5/4	15.5	63	2	1800	4010	294
	QDTA2100/34/2-3/G/P	3/4	6.6	34	2	2100	2150	215
	QDTA2100/43/2-4/G/P	4/4	8.6	43	2	2100	2600	220
	QDTA2100/47/2-5.5/G/P	5.5/4	11.3	47	2	2100	3350	300
	QDTA2100/52/2-7.5/G/P	7.5/4	15.5	52	2	2100	3900	305
	QDTA2500/34/2-3/G/P	3/4	6.6	34	2	2500	2500	220
	QDTA2500/43/2-4/G/P	4/4	9.3	43	2	2500	3200	223
	QDTA2500/47/2-5.5/G/P	5.5/4	12	47	2	2500	3840	310
	QDTA2500/52/2-7.5/G/P	7.5/4	15.5	52	2	2500	4280	315
	QDTA1100/52/3-3/G/P	3/4	6.6	52	3	1100	1600	182
	QDTA1100/85/3-5.5/G/P	5.5/4	11.3	85	3	1100	2320	187
	QDTA1400/34/3-3/G/P	3/4	6.6	34	3	1400	1870	193
	QDTA1400/63/3-7.5/G/P	7.5/4	15.5	63	3	1400	3300	198
	QDTA1800/34/3-3/G/P	3/4	6.6	34	3	1800	2040	220
	QDTA1800/52/3-5.5/G/P	5.5/4	12	52	3	1800	3320	306
	QDTA1800/47/3-7.5/G	7.5/4	15.5	47	3	1800	4010	312
	QDTA2100/39/3-4/G/P	4/4	8.6	39	3	2100	2550	245
	QDTA2100/43/3-5.5/G/P	5.5/4	11.3	43	3	2100	3320	295
	QDTA2100/47/3-7.5/G	7.5/4	15.5	47	3	2100	4030	300
QDTA2500/43/3-5.5/G/P	5.5/4	12	43	3	2500	3840	327	
QDTA2500/43/3-7.5/G	7.5/4	15.5	43	3	2500	4280	330	
填料流化 MBBR Flow	QDTM1080/102/3-3	3/8	7.8	102	3	1080	1600	170
	QDTM1200/102/3-4	4/8	10	102	3	1200	2050	175
	QDTM1200/121/3-5.5	5.5/8	13.3	121	3	1200	2640	185
	QDTM1200/121/3-7.5	7.5/8	17.7	121	3	1200	3460	190
	QDTM1320/142/3-11	11/8	25.1	142	3	1320	4250	290
	QDTM1450/142/3-15	15/8	34.1	142	3	1450	4660	340

注： 1、电机绕组绝缘等级：F级，防护等级：IP68，电机工作制式：24小时连续工作。  
2、可提供H级绝缘电机。

Notes: 1、Winding insulation class of the motor: Class F; Protective grade; IP68; Operating mode :Operation for 24 hours  
2、We can supply the motor with class H winding insulation

## 选型参考 Reference for Type Selection

潜水推流机的选型是一项比较复杂的工作，选型方案的正确与否直接影响到设备的正常使用，作为选型的原则就是要让推流机在适合的容积里发挥充分的推流功能，这个标准一般可用流速来确定。根据污水处理厂的不同工艺要求，搅拌机选型的最佳流速应保证在 $0.15\sim 0.3\text{m/s}$ 之间，如果低于 $0.15\text{m/s}$ 的流速则达不到推流搅拌的效果，如果超过 $0.3\text{m/s}$ 的流速则会影响工艺效果且造成浪费。所以在选型前，首先要确定潜水推流机运用在什么场所，如：污水池、污泥池还是生化池；其次是介质参数，如：悬浮物含量、温度、PH值等；还有水池的形状，水深甚至安装方式等都将对选型产生影响，同时还应考虑到节能因素，因为这将会影响到用户今后的运行成本。

为了满足在不同环境下都能达到最佳的推流效果，我们为用户提供了多种型号的潜水推流机，同时可提供选型服务。可参考下面的潜水推流机流场图。



The type selection of submersible mixer is a rather complicated job. The correctness of the type selection will directly affect the normal usage of the equipment. The principle for the type selection is to enable mixer to give full play to its mixing function in the appropriate volume. This standard can generally be determined by the flow velocity. In line with the different technological requirement of the sewage treatment, the optimum flow velocity for the mixer type selection shall ensure the velocity range of  $0.15\sim 0.3\text{m/s}$ . In case of the flow velocity lower than  $0.15\text{m/s}$ , the effectiveness of agitation or mixing can not be achieved. In case of the flow velocity bigger than  $0.3\text{m/s}$ , the technological effectiveness will be affected and waste will be caused. Therefore, before type selection, it is necessary to determine what kind of environment the mixer will be used in, for instance, sewage tank, slag pond or biochemical pond. Secondly, the parameters of the medium such as content of the suspended substances, temperature, pH value as well as the shape of the pond, water depth and even the mode of installation and so on will all influence the type selection. Meanwhile, it is also necessary to consider the energy-saving factor, because this will influence the operating cost of the users in the future.

For the purpose of fulfilling the optimum mixing function in different environments, we can supply multiple types of the submersible mixers to the users and provide type selection service as well. Refer to the following diagrams of the flow field of submersible mixer.





## 潜水推流器流场图 Diagrams of the Flow Field Submersible flow propeller

该流速场是在清水中边界流速 $V=0.1\text{m/s}$

This flow velocity fields are located in the clear water with the boundary water flow velocity of  $V=0.1\text{m/s}$

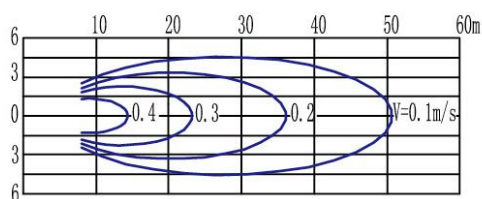

QDTA1100/43/2-1.5/G

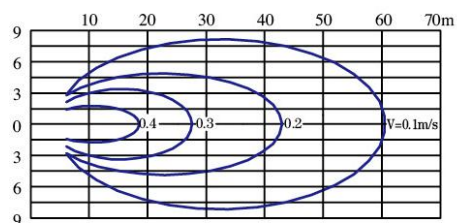

QDTA1400/34/2-2.2/G, QDTA1100/52/2-2.2/G

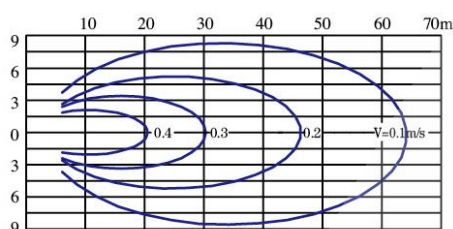

QDTA1100/63/2-3/G, QDTA1100/52/3-3/G

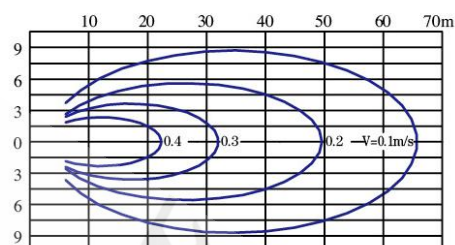

QDTA1400/52/2-4/G, QDTA1100/85/2-4/G

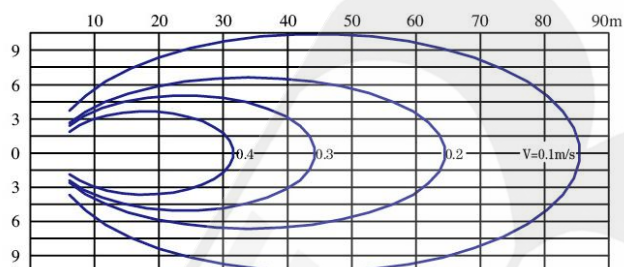

QDTA1100/85/3-5.5/G

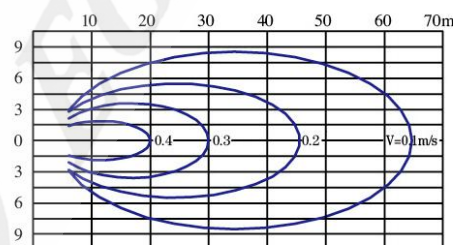

QDTA1800/34/2-3/G, QDTA1400/43/2-3/G  
QDTA1400/34/3-3/G, QDTA2100/32/2-3/G

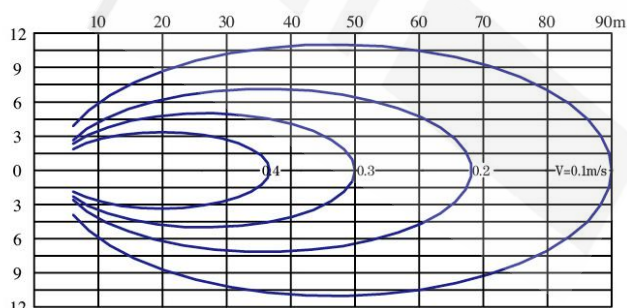

QDTA1400/63/2-5.5/G

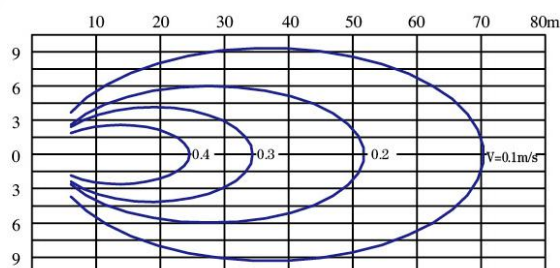

QDTA1800/43/2-4/G

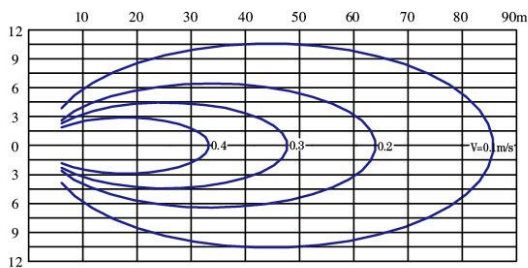

QDTA1800/47/2-5.5/G QDTA2100/47/2-5.5/G

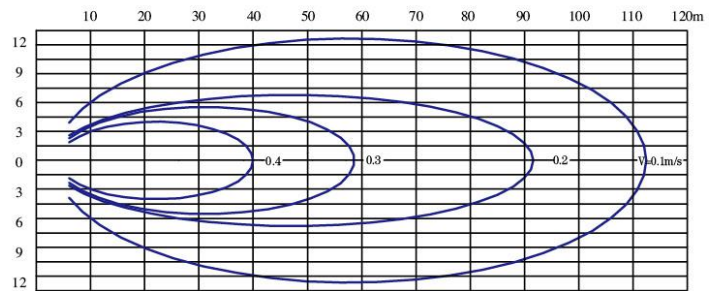

QDTA1800/63/2-7.5/G QDTA1400/63/3-7.5/G

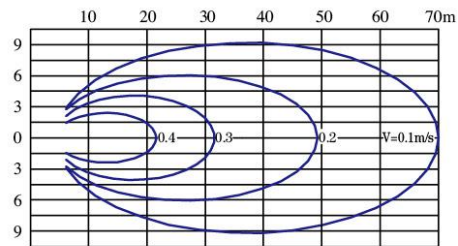

QDTA2500/34/2-3/G QDTA1800/34/3-3/G

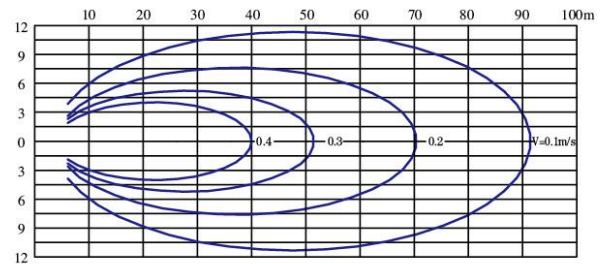

QDTA1800/52/3-5.5/G

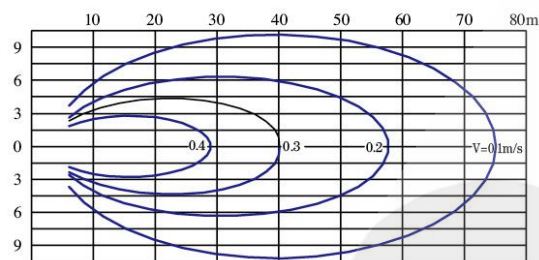

QDTA2500/43/2-4/G

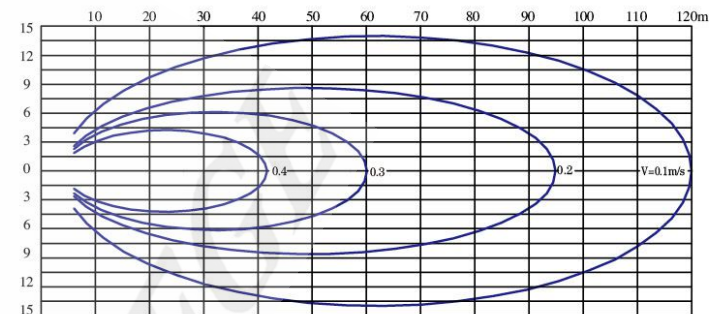

QDTA2500/52/2-7.5/G, QDTA1800/47/3-7.5/G  
QDTA2100/47/3-7.5/G

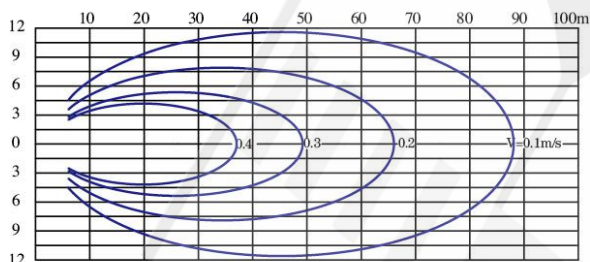

QDTA2100/43/3-5.5/G

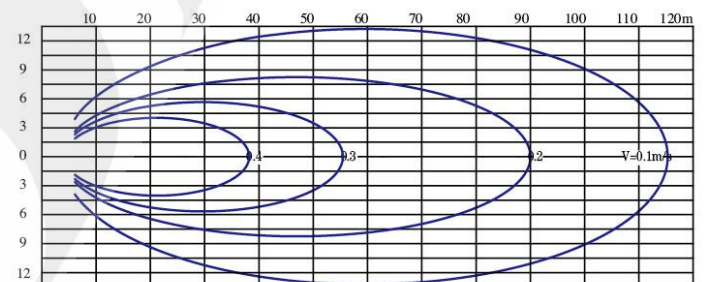

QDTA2100/52/2-7.5/G

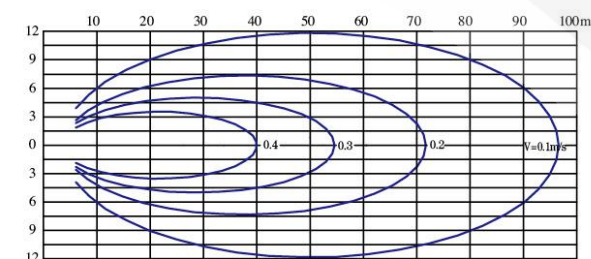

QDTA2500/47/2-5.5/G, QDTA2500/43/3-5.5/G

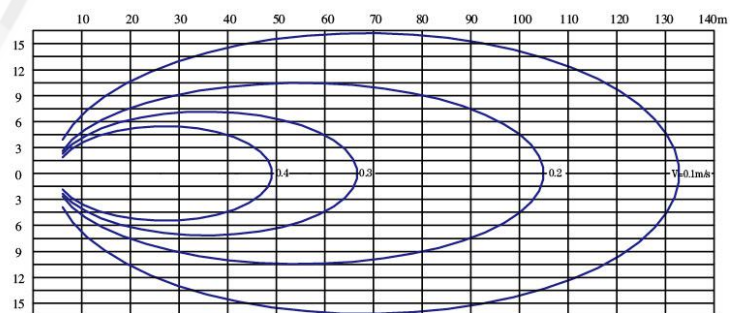

QDTA2500/43/3-7.5/G



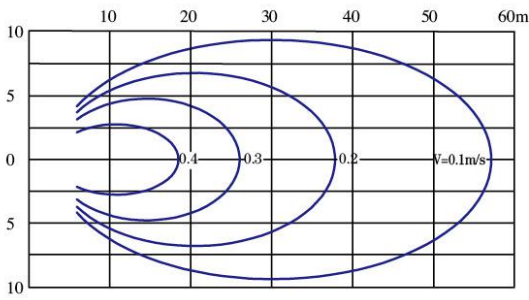

QDTM1080/102/3-3

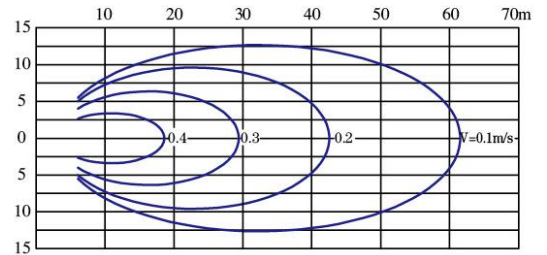

QDTM1080/102/3-4

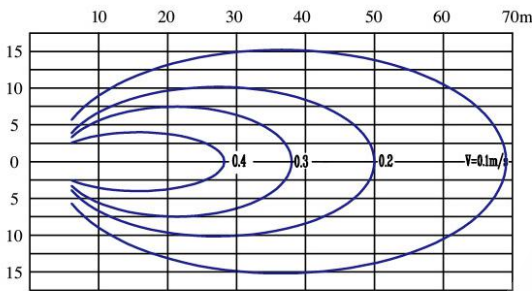

QDTM1080/121/3-5.5

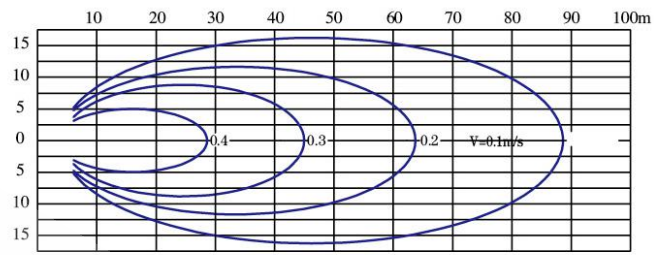

QDTM1080/121/3-7.5

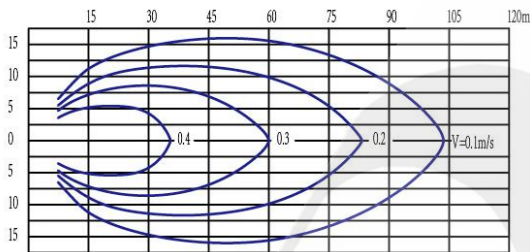

QDTM1320/142/3-11

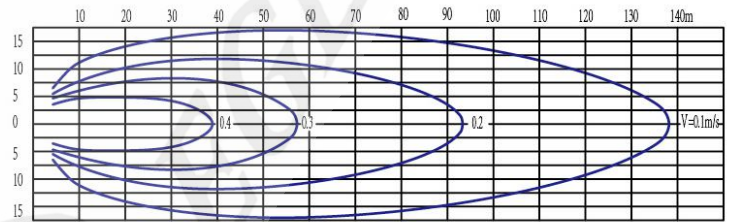

QDTM1450/142/3-15



## 潜水推流器运行模式 Operating Modes of Submersible flow propeller

潜水推流器的安装定位对其搅拌效果有很大的影响，为了达到预期的运行效果，我们建议用户按照专业设计人员的要求去做，要充分考虑到水池的形状，进出水的位置以及搅拌机的水流反射到构筑物后引起的涡流等情况，尽量减少短路循环和死角产生，避免与池壁的正面撞击而降低流速。参照下面的运行模式图，可帮助您合理选择搅拌机和安装形式。

The installation and positioning of the submersible mixers will have great impact on the mixing effectiveness. In order to get twice result with the half the effort, We suggest the users follow the advice of professional designers and fully consider the pond shape, position of the water inlet and outlet, as well as the vortex resulting from the water flow from the mixer reflex to the structures, try to reduce the short-circuit circulation and dead corners, and avoid the dashing of the flow against the pond wall to retard the flow velocity, Refer to the following diagrams of operating modes, which can help you make a reasonable selection of the mixers and the installation modes



方形池 Square pond



矩形池 Rectangular pond

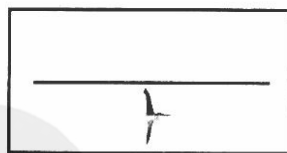

路道形池 Road-shaped pond

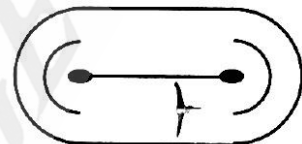

圆形池 Circular pond

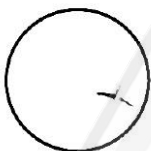

环形池 Ring-shaped pond



S 曲线形池 S-shaped pond

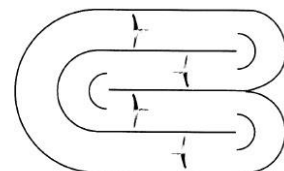



## 安装方式及尺寸 Installation Modes and Dimensions

潜水推流器可以有多种安装方式，这里提供两种最通用的方式供选择，尺寸可参考下表。我公司还可以根据用户的要求作特殊设计。

The submersible mixers can have multiple installation modes, Here are two generally accepted modes of installation for selection with reference to following table, Our company can also provide the special designs in accordance with the requirements of the users.

型号Type	a	D	b	L	H1min	H2min	安装系统 Installation system
QDTA1100/43/2-1.5/G/P	□100	Φ1100	210	1100	1000	270	IV
QDTA1100/52/2-2.2/G/P	□100	Φ1100	210	1100	1000	270	IV
QDTA1100/63/2-3/G/P	□100	Φ1100	210	1100	1000	270	IV
QDTA1100/85/2-4/G/P	□100	Φ1100	210	1150	1000	270	IV
QDTA1400/34/2-2.2/G/P	□100/Φ89	Φ1400	210/600	1100/1050	800	125	IV/V
QDTA1400/43/2-3/G/P	□100/Φ89	Φ1400	210/600	1100/1050	800	125	IV/V
QDTA1400/52/2-4/G/P	□100/Φ89	Φ1400	210/600	1150/1050	800	125	IV/V
QDTA1400/63/2-5.5/G/P	□100/Φ89	Φ1400	210/600	1150/1050	800	125	IV/V
QDTA1800/34/2-3/G	□100/Φ89	Φ1800	210/600	1100/1050	800	125	IV/V
QDTA1800/43/2-4/G	□100/Φ89	Φ1800	210/600	1150/1050	800	125	IV/V
QDTA1800/47/2-5.5/G	□100/Φ102	Φ1800	200/600	1190/1050	800	125	IV/V
QDTA1800/63/2-7.5/G/P	□100/Φ102	Φ1800	200/600	1190/1050	800	125	IV/V
QDTA2100/34/2-3/G/P	□100/Φ89	Φ2100	210/600	1100/1050	900	125	IV/V
QDTA2100/43/2-4/G/P	□100/Φ89	Φ2100	210/600	1150/1050	900	125	IV/V
QDTA2100/47/2-5.5/G/P	□100/Φ102	Φ2100	200/600	1190/1050	900	125	IV/V
QDTA2100/52/2-7.5/G/P	□100/Φ102	Φ2100	200/600	1190/1050	900	125	IV/V
QDTA2500/34/2-3/G/P	□100/Φ89	Φ2500	210/600	1100/1050	1000	125	IV/V
QDTA2500/43/2-4/G/P	□100/Φ89	Φ2500	210/600	1150/1050	1000	125	IV/V
QDTA2500/47/2-5.5/G/P	□100/Φ102	Φ2500	200/600	1190/1050	1000	125	IV/V
QDTA2500/52/2-7.5/G/P	□100/Φ102	Φ2500	200/600	1190/1050	1000	125	IV/V
QDTA1100/52/3-3/G/P	□100	Φ1100	210	1100	1000	270	IV
QDTA1100/85/3-5.5/G/P	□100	Φ1100	210	1150	1000	270	IV
QDTA1400/34/3-3/G/P	□100/Φ89	Φ1400	210/600	1100/1050	800	125	IV/V
QDTA1400/63/3-7.5/G/P	□100/Φ102	Φ1400	200/600	1190/1050	800	125	IV/V
QDTA1800/34/3-3/G/P	□100/Φ89	Φ1800	210/600	1100/1050	800	125	IV/V
QDTA1800/52/3-5.5/G/P	□100/Φ102	Φ1800	200/600	1190/1050	800	125	IV/V
QDTA1800/47/3-7.5/G	□100/Φ102	Φ1800	200/600	1190/1050	800	125	IV/V
QDTA2100/39/3-4/G/P	□100/Φ89	Φ2100	210/600	1150/1050	900	125	IV/V
QDTA2100/43/3-5.5/G/P	□100/Φ102	Φ2100	200/600	1190/1050	900	125	IV/V
QDTA2100/47/3-7.5/G	□100/Φ102	Φ2100	200/600	1190/1050	900	125	IV/V
QDTA2500/43/3-5.5/G/P	□100/Φ102	Φ2500	200/600	1190/1050	1000	125	IV/V
QDTA2500/43/3-7.5/G	□100/Φ102	Φ2500	200/600	1190/1050	1000	125	IV/V
QDTM1080/102/3-3	□100	1080	335	-	-	-	III-1
QDTM1080/102/3-4	□100	1080	335	-	-	-	III-1
QDTM1080/121/3-5.5	□100	1080	335	-	-	-	III-1
QDTM1080/121/3-7.5	□100	1080	335	-	-	-	III-1

**潜水推流器安装示意图** Installation diagram of Submersible flow propeller

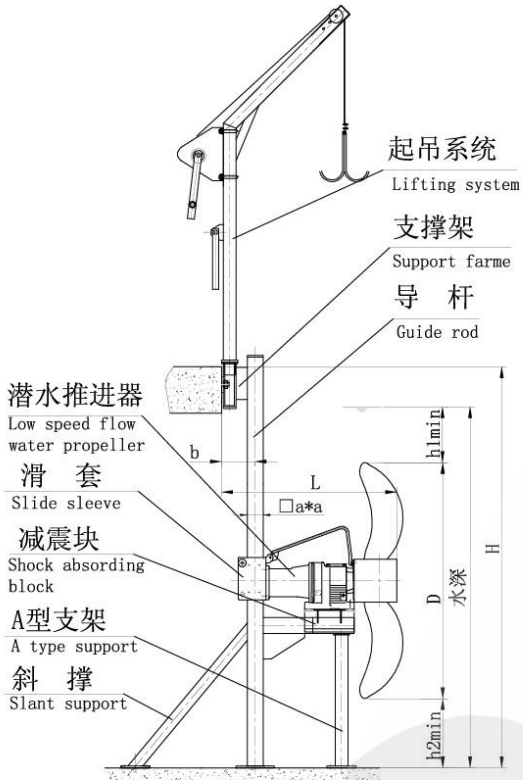

IV 单导轨型 Single-rail type

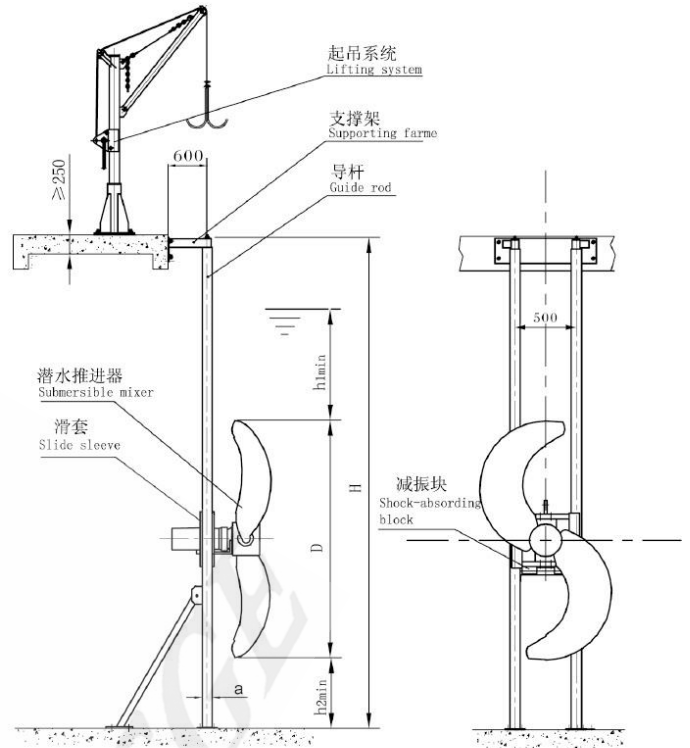

V 双导杆型 Double guide rod type

